

# Fittings for Butt Fusion

35 01 87

## Bend 90°, PN 16, PVDF-HP

K

- \* new model with compact design and optimized flow values

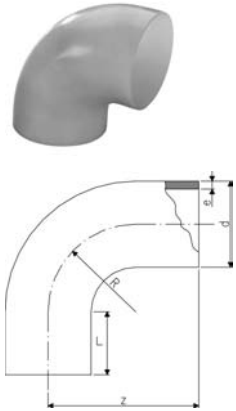

PF 2 37 249

d [mm]	PN	Code	kg	e [mm]	L [mm]	z [mm]	R [mm]
*20	16	<b>735 018 731</b>	0.015	1.9	23	38	15
*25	16	<b>735 018 732</b>	0.021	1.9	23	42	19
*32	16	<b>735 018 733</b>	0.035	2.4	22	46	24
*40	16	<b>735 018 734</b>	0.050	2.4	21	51	30
*50	16	<b>735 018 735</b>	0.087	3.0	21	58	37
*63	16	<b>735 018 736</b>	0.128	3.0	21	66	45
75	16	<b>735 018 737</b>	0.243	3.6	23	75	62
90	16	<b>735 018 738</b>	0.385	4.3	23	90	77
110	16	<b>735 018 739</b>	0.643	5.3	23	110	98
140	16	<b>735 018 741</b>	1.423	6.7	33	140	121
160	16	<b>735 018 742</b>	2.052	7.7	33	160	141
200	16	<b>735 018 744</b>	3.798	9.6	33	200	181
225	16	<b>735 018 745</b>	5.274	10.8	33	220	200

35 01 85

## Bend 90°, PN 10, PVDF-HP

K

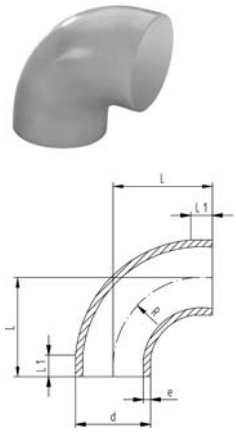

PF 2 37 249

d [mm]	PN	Code	kg	e [mm]	L [mm]	L1 [mm]	e1 [mm]	L2 [mm]
90	10	<b>735 018 538</b>	0.294	2.8	90	23		
110	10	<b>735 018 539</b>	0.578	3.4	110	23		
125	10	<b>735 018 540</b>	0.670	3.9	125	28		
140	10	<b>735 018 541</b>	0.970	4.3	140	33		
160	10	<b>735 018 542</b>	1.440	4.7	160	33		
200	10	<b>735 018 544</b>	2.730	6.2	200	33		
225	10	<b>735 018 545</b>	3.900	6.9	220	33		
250	10	<b>735 018 546</b>	8.040	7.7	254	48		
*280	10	<b>735 018 547</b>	11.200	8.6	283	48	17.2	10
*315	10	<b>735 018 548</b>	15.900	9.7	321	48	19.3	10

35 10 86

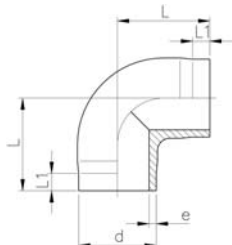
**Elbow 90°, PN 16, PVDF-HP****K**

PF 2 37 249

d [mm]	PN	Code	kg	e [mm]	L [mm]	L1 [mm]
20	16	<b>735 108 631</b>	0.017	1.9	38	25
25	16	<b>735 108 632</b>	0.023	1.9	42	26
32	16	<b>735 108 633</b>	0.040	2.4	46	26
40	16	<b>735 108 634</b>	0.060	2.4	51	28
50	16	<b>735 108 635</b>	0.105	3.0	58	28
63	16	<b>735 108 636</b>	0.180	3.0	66	28

35 15 86

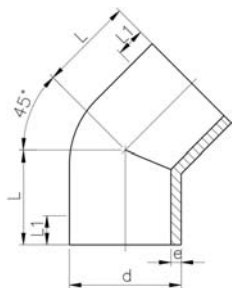
**Elbow 45°, PN 16, PVDF-HP****K**

PF 2 37 249

d [mm]	PN	Code	kg	e [mm]	L [mm]	L1 [mm]
20	16	<b>735 158 631</b>	0.014	1.9	32	25
25	16	<b>735 158 632</b>	0.019	1.9	34	26
32	16	<b>735 158 633</b>	0.033	2.4	36	26
40	16	<b>735 158 634</b>	0.048	2.4	39	28
50	16	<b>735 158 635</b>	0.079	3.0	42	30
63	16	<b>735 158 636</b>	0.116	3.0	47	31
75	16	<b>735 158 637</b>	0.160	3.6	49	32
90	16	<b>735 158 638</b>	0.260	4.3	57	37
110	16	<b>735 158 639</b>	0.480	5.3	70	46
140	16	<b>735 158 641</b>	1.000	6.7	88	57
160	16	<b>735 158 642</b>	2.300	7.7	100	62
200	16	<b>735 158 644</b>	2.800	9.6	124	77
225	16	<b>735 158 645</b>	4.000	10.8	140	88

35 15 85

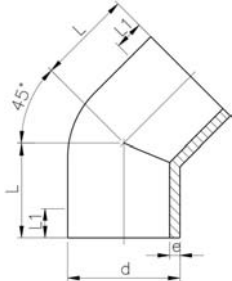
**Elbow 45°, PN 10, PVDF-HP****K**

PF 2 37 249

d [mm]	PN	Code	kg	e [mm]	L [mm]	L1 [mm]
90	10	<b>735 158 538</b>	0.181	2.8	57	37
110	10	<b>735 158 539</b>	0.330	3.4	70	46
125	10	<b>735 158 540</b>	0.490	3.9	79	51
140	10	<b>735 158 541</b>	0.680	4.3	88	57
160	10	<b>735 158 542</b>	0.990	4.9	100	62
200	10	<b>735 158 544</b>	1.940	6.2	124	77
225	10	<b>735 158 545</b>	2.780	6.9	140	88

35 20 86

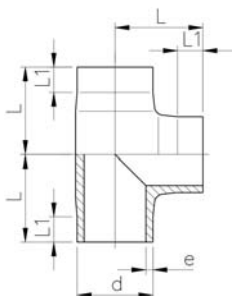
**T 90° equal ; PN 16, PVDF-HP****K**

PF 2 37 249

d [mm]	PN	Code	kg	e [mm]	L [mm]	L1 [mm]
20	16	<b>735 208 631</b>	0.023	1.9	38	25
25	16	<b>735 208 632</b>	0.032	1.9	42	27
32	16	<b>735 208 633</b>	0.056	2.4	46	27
40	16	<b>735 208 634</b>	0.083	2.4	51	28
50	16	<b>735 208 635</b>	0.140	3.0	58	28
63	16	<b>735 208 636</b>	0.231	3.0	66	28
75	16	<b>735 208 637</b>	0.370	3.6	75	32
90	16	<b>735 208 638</b>	0.660	4.3	90	39
110	16	<b>735 208 639</b>	1.210	5.3	110	48
140	16	<b>735 208 641</b>	2.600	6.7	140	62
160	16	<b>735 208 642</b>	5.200	7.7	160	71
200	16	<b>735 208 644</b>	6.630	9.6	200	80
225	16	<b>735 208 645</b>	9.120	10.8	220	86

35 20 85

**T 90° equal, PN 10, PVDF-HP**

**K**

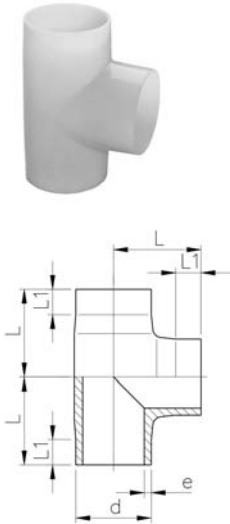

PF 2 37 249

d [mm]	PN	Code	kg	e [mm]	L [mm]	L1 [mm]
90	10	<b>735 208 538</b>	0.397	2.8	90	39
110	10	<b>735 208 539</b>	0.714	3.4	110	48
125	10	<b>735 208 540</b>	1.280	3.9	125	56
140	10	<b>735 208 541</b>	1.780	4.3	140	62
160	10	<b>735 208 542</b>	2.570	4.9	160	71
200	10	<b>735 208 544</b>	4.297	6.2	200	80
225	10	<b>735 208 545</b>	6.800	6.9	220	86
250	10	<b>735 208 546</b>	9.281	7.7	223	61
280	10	<b>735 208 547</b>	13.608	8.6	256	74
315	10	<b>735 208 548</b>	18.128	9.7	274	74

**35 20 89 / 35 20 86 T 90° reduced; PN16, PVDF-HP**

**K**

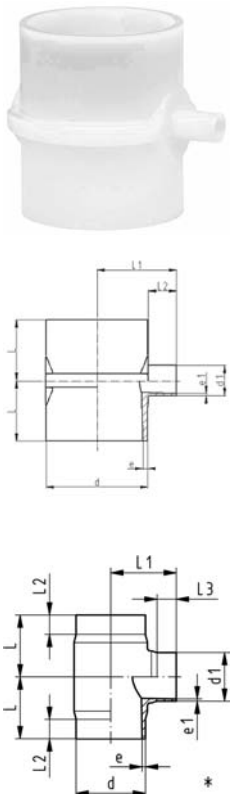

PF 2 37 425

d - d1 [mm]	PN	Code	kg	e [mm]	e1 [mm]	L [mm]	L1 [mm]	L2 [mm]	L3 [mm]
63 - 20	16	<b>735 208 956</b>	0.213	3.0	1.9	60	67	25	35
63 - 25	16	<b>735 208 957</b>	0.214	3.0	1.9	60	66	25	34
63 - 32	16	<b>735 208 958</b>	0.220	3.0	2.4	60	67	25	25
63 - 40	16	<b>735 208 959</b>	0.217	3.0	2.4	60	66	25	26
75 - 20	16	<b>735 208 961</b>	0.306	3.6	1.9	65	69	25	31
75 - 25	16	<b>735 208 962</b>	0.308	3.6	1.9	65	72	25	34
75 - 32	16	<b>735 208 963</b>	0.308	3.6	2.4	65	69	25	31
75 - 40	16	<b>735 208 964</b>	0.312	3.6	2.4	65	72	25	26
75 - 50	16	<b>735 208 965</b>	0.309	3.6	3.0	65	69	25	26
90 - 20	16	<b>735 208 967</b>	0.403	4.3	1.9	65	76	25	31
90 - 25	16	<b>735 208 968</b>	0.405	4.3	1.9	65	79	25	34
90 - 32	16	<b>735 208 969</b>	0.405	4.3	2.4	65	76	25	31
90 - 40	16	<b>735 208 970</b>	0.409	4.3	2.4	65	79	25	26
90 - 50	16	<b>735 208 971</b>	0.406	4.3	3.0	65	76	25	26
*90 - 63	16	<b>735 208 972</b>	0.540	4.3	3.0	80	85	25	25
110 - 20	16	<b>735 208 974</b>	0.568	5.3	1.9	65	86	25	31
110 - 25	16	<b>735 208 975</b>	0.570	5.3	1.9	65	89	25	34
110 - 32	16	<b>735 208 976</b>	0.570	5.3	2.4	65	86	25	31
110 - 40	16	<b>735 208 977</b>	0.572	5.3	2.4	65	89	25	26
110 - 50	16	<b>735 208 978</b>	0.568	5.3	3.0	65	86	25	26
*110 - 63	16	<b>735 208 979</b>	0.853	5.3	3.0	90	95	30	25
*110 - 75	16	<b>735 208 980</b>	0.863	5.3	3.0	90	95	30	25
*110 - 90	16	<b>735 208 981</b>	0.870	5.3	4.3	90	95	30	25
*160 - 90	16	<b>735 208 687</b>	3.200	7.7	4.3	155	130	60	25
*160 - 110	16	<b>735 208 686</b>	3.300	7.7	5.3	155	130	60	25
*225 - 90	16	<b>735 208 695</b>	6.000	10.8	4.3	155	160	60	25
*225 - 110	16	<b>735 208 694</b>	6.100	10.8	5.3	155	160	60	25

35 20 85

## T 90° reduced; PN 10, PVDF-HP

K

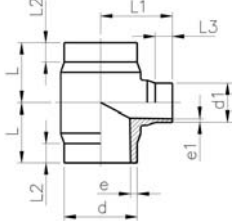

PF 2 37 425

d - d1 [mm]	PN [bar]	Code	kg	e [mm]	e1 [mm]	L [mm]	L1 [mm]	L2 [mm]	L3 [mm]
160 - 90	10 / 16	<b>735 208 587</b>	2.300	4.9	4.3	155	130	60	25
160 - 110	10 / 16	<b>735 208 586</b>	2.300	4.9	5.3	155	130	60	25
225 - 90	10 / 16	<b>735 208 595</b>	4.400	6.9	4.3	155	160	60	25
225 - 110	10 / 16	<b>735 208 594</b>	4.400	6.9	5.3	155	160	60	25

35 91 86

## Restraint Fitting, PN 16, PVDF-HP

K

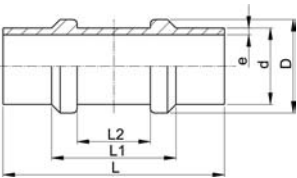

PF 2 37 249

d [mm]	PN	Code	kg	D [mm]	e [mm]	L [mm]	L1 [mm]	L2 [mm]
20	16	<b>735 918 656</b>	0.027	28	1.9	100	53	32
25	16	<b>735 918 657</b>	0.036	33	1.9	100	53	32
32	16	<b>735 918 658</b>	0.054	40	2.4	100	53	32
40	16	<b>735 918 659</b>	0.067	48	2.4	100	53	32
50	16	<b>735 918 660</b>	0.100	58	3.0	100	53	32
63	16	<b>735 918 661</b>	0.131	71	3.0	105	53	32
75	16	<b>735 918 662</b>	0.252	87	3.6	125	70	40
90	16	<b>735 918 663</b>	0.353	105	4.3	125	70	40
110	16	<b>735 918 664</b>	0.516	127	5.3	125	70	40

35 91 88

## Instrument Installation Fitting, PN16, PVDF-HP

K

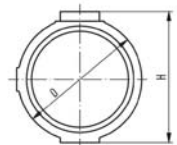
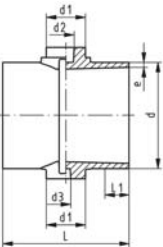

PF 2 37 425

## Model:

- Suitable for hole diameters from 1/4 - 3/4
- Injection-moulded version

## Note:

- Hole needs to be milled, HAND HELD DRILLING MUST NOT BE DONE

d [mm]	PN	Code	kg	D [mm]	e [mm]	d1 [mm]	d2 [mm]	H [mm]	L [mm]	L1 [mm]
63	16	<b>735 918 811</b>	0.235	85	3.0	40	17	89	120	25
75	16	<b>735 918 812</b>	0.326	96	3.6	40	17	101	130	25
90	16	<b>735 918 813</b>	0.418	110	4.3	40	17	116	130	25
110	16	<b>735 918 814</b>	0.561	127	5.3	40	17	136	130	25

35 91 86

**Instrument Installation Fitting, PN 16, PVDF-HP**

**K**

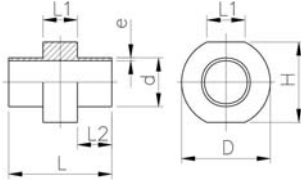

**Model:**

- Suitable for hole diameters from 1/8 - 3/4
- Machined version

**Note:**

- Hole needs to be milled, HAND HELD DRILLING MUST NOT BE DONE

\* no stock item

d [mm]	PN	Code	kg	D [mm]	e [mm]	H [mm]	L [mm]	L1 [mm]	L2 [mm]
*63	16	<b>735 918 611</b>	0.495	105	3.0	97	100	40	27
*75	16	<b>735 918 612</b>	0.554	115	3.6	108	90	40	22
*90	16	<b>735 918 613</b>	0.649	128	4.3	121	90	40	22
*110	16	<b>735 918 614</b>	0.778	145	5.3	139	90	40	22
*125	16	<b>735 918 615</b>	1.007	162	6.0	157	100	40	27
*140	16	<b>735 918 616</b>	1.185	176	6.7	171	110	40	32
*160	16	<b>735 918 617</b>	1.405	194	7.7	190	110	40	32
*200	16	<b>735 918 619</b>	1.871	231	9.6	228	110	40	32
*225	16	<b>735 918 620</b>	2.284	254	10.8	251	110	40	32

PF 2 37 425

35 91 85

**Instrument Installation Fittings ; PN 10, PVDF-HP**

**K**

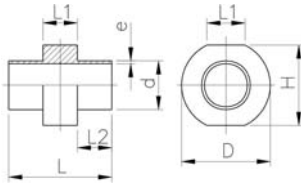

**Model:**

- Suitable for hole diameters from 1/8 - 3/4
- Machined version

**Note:**

- Hole needs to be milled, HAND HELD DRILLING MUST NOT BE DONE

d [mm]	PN	Code	kg	D [mm]	e [mm]	H [mm]	L [mm]	L1 [mm]	L2 [mm]
125	10	<b>735 918 565</b>	0.858	162	3.9	157	100	40	27
140	10	<b>735 918 566</b>	1.003	176	4.4	171	110	40	32
160	10	<b>735 918 567</b>	1.151	194	4.9	190	110	40	32
200	10	<b>735 918 569</b>	1.486	231	6.2	228	110	40	32
225	10	<b>735 918 570</b>	3.151	254	7.0	251	110	40	32

PF 2 37 425

## SYGEF® Standard Sensor Connection Tee

The maximal solution  
for a minimal dead leg



### Your benefit with the Sensor Connection Tee:

- Easier cleaning (CIP)
- Minimal Biofilm building up
- Reduced installation costs
- Compact design
- Reliable sensor connection
- Fulfills FDA and USP class VI

### All available standards:

- ISO 1127
- DIN 32676
- ASME BPE
- MM
- 3A
- ISO 2852
- BS 4825 Metric & Inch
- DIN 3017
- JIS G3447
- SYGEF-Plus

### The SCT at a glance:

- Main line sizes d20 to d110 compatible with IR-Plus® & BCF®Plus fusion
- PN16 welding dimension (PN10 for d90 & d110 also available)
- Clamp connection up from d20 to d75 depending on main line dimension
- Fully customised solution, to suit your application

→ Please contact GF for further technical information

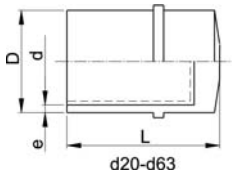

## Caps, PVDF-HP

K

d [mm]	PN	Code	kg	e [mm]	L [mm]
20	16	<b>735 991 651</b>	0.020	1.9	47
25	16	<b>735 991 652</b>	0.028	1.9	48
32	16	<b>735 991 653</b>	0.050	2.4	52
40	16	<b>735 991 654</b>	0.068	2.4	59
50	16	<b>735 991 655</b>	0.107	3.0	64
63	16	<b>735 991 656</b>	0.165	3.0	69
75	16	<b>735 991 657</b>	0.283	3.6	40
90	16	<b>735 991 658</b>	0.509	4.3	40
110	16	<b>735 991 659</b>	0.812	5.3	40
160	10	<b>735 991 661</b>	1.046	4.9	50
200	10	<b>735 991 662</b>	1.637	6.2	50
225	10	<b>735 991 663</b>	2.072	6.9	50

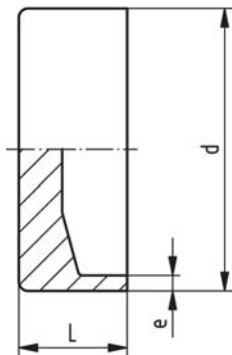

PF 2 65 460

## Reducing Bush, eccentric, PN 16, PVDF-HP

K

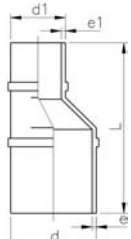

PF 2 65 433

d - d1 [mm]	Code	kg	e [mm]	e1 [mm]	L [mm]
25 - 20	<b>735 938 737</b>	0.020	1.9	1.9	80
32 - 20	<b>735 938 742</b>	0.027	2.4	1.9	80
32 - 25	<b>735 938 741</b>	0.028	2.4	1.9	80
40 - 20	<b>735 938 748</b>	0.041	2.4	1.9	100
40 - 25	<b>735 938 747</b>	0.042	2.4	1.9	100
40 - 32	<b>735 938 746</b>	0.049	2.4	2.4	100
50 - 32	<b>735 938 753</b>	0.066	3.0	2.4	100
50 - 40	<b>735 938 752</b>	0.069	3.0	2.4	100
63 - 32	<b>735 938 760</b>	0.083	3.0	2.4	100
63 - 40	<b>735 938 759</b>	0.084	3.0	2.4	100
63 - 50	<b>735 938 758</b>	0.096	3.0	3.0	100



35 90 86

## Reducer, PN 16, PVDF-HP

K

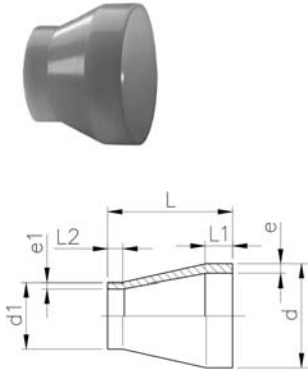

d - d1 [mm]	PN	Code	kg	e [mm]	e1 [mm]	L [mm]	L1 [mm]	L2 [mm]
25 - 20	16	<b>735 908 600</b>	0.012	1.9	1.9	50	22	22
32 - 20	16	<b>735 908 602</b>	0.017	2.4	1.9	50	22	22
32 - 25	16	<b>735 908 601</b>	0.018	2.4	1.9	50	22	22
40 - 20	16	<b>735 908 605</b>	0.024	2.4	1.9	58	22	24
40 - 25	16	<b>735 908 604</b>	0.025	2.4	1.9	55	22	24
40 - 32	16	<b>735 908 603</b>	0.029	2.4	2.4	55	22	24
50 - 25	16	<b>735 908 608</b>	0.031	3.0	1.9	60	22	25
50 - 32	16	<b>735 908 607</b>	0.038	3.0	2.4	60	22	25
50 - 40	16	<b>735 908 606</b>	0.040	3.0	2.4	60	22	25
63 - 32	16	<b>735 908 611</b>	0.050	3.0	2.4	65	22	25
63 - 40	16	<b>735 908 610</b>	0.052	3.0	2.4	65	22	25
63 - 50	16	<b>735 908 609</b>	0.060	3.0	3.0	65	22	25
75 - 40	16	<b>735 908 614</b>	0.069	3.6	2.4	68	24	25
75 - 50	16	<b>735 908 613</b>	0.078	3.6	3.0	65	24	25
75 - 63	16	<b>735 908 612</b>	0.080	3.6	3.0	65	24	25
90 - 63	16	<b>735 908 616</b>	0.120	4.3	3.0	75	25	30
90 - 75	16	<b>735 908 615</b>	0.130	4.3	3.6	75	25	35
110 - 63	16	<b>735 908 619</b>	0.225	5.3	3.0	90	30	30
110 - 75	16	<b>735 908 618</b>	0.220	5.3	3.6	90	30	35
110 - 90	16	<b>735 908 617</b>	0.230	5.3	4.3	90	30	35
140 - 110	16	<b>735 908 621</b>	0.450	6.7	5.3	110	40	40
160 - 110	16	<b>735 908 623</b>	1.000	7.7	5.3	120	40	40
160 - 140	16	<b>735 908 622</b>	0.660	7.7	6.7	120	40	40
200 - 160	16	<b>735 908 624</b>	1.340	9.6	7.7	145	40	35
225 - 110	16	<b>735 908 625</b>	1.540	10.8	5.3	160	55	40
225 - 160	16	<b>735 908 626</b>	1.730	10.8	7.7	160	55	28
225 - 200	16	<b>735 908 627</b>	1.980	10.8	9.6	160	55	50

PF 2 37 249

35 90 85

## Reducer, PN 10, PVDF-HP

K

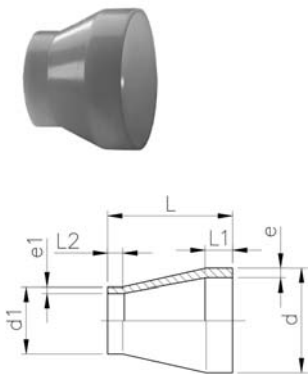

d - d1 [mm]	PN [bar]	Code	kg	e [mm]	e1 [mm]	L [mm]	L1 [mm]	L2 [mm]
90 - 63	10 / 16	<b>735 908 511</b>	0.102	2.8	3.0	75	25	30
110 - 63	10 / 16	<b>735 908 513</b>	0.164	3.4	3.0	90	30	30
110 - 90	10 / 10	<b>735 908 515</b>	0.167	3.4	2.8	90	30	35
125 - 110	10 / 16	<b>735 908 500</b>	0.270	3.9	5.3	100	35	40
140 - 110	10 / 16	<b>735 908 502</b>	0.385	4.3	5.3	110	40	40
140 - 125	10 / 10	<b>735 908 501</b>	0.340	4.3	3.9	110	40	40
160 - 110	10 / 10	<b>735 908 521</b>	0.449	4.9	3.4	120	40	40
160 - 110	10 / 16	<b>735 908 504</b>	0.425	4.9	5.3	120	40	40
160 - 140	10 / 10	<b>735 908 503</b>	0.460	4.9	4.3	120	40	40
200 - 160	10 / 10	<b>735 908 505</b>	0.830	6.2	4.9	145	50	40
225 - 110	10 / 10	<b>735 908 526</b>	1.120	6.9	3.4	160	55	35
225 - 110	10 / 16	<b>735 908 506</b>	0.940	6.9	5.3	160	55	35
225 - 160	10 / 10	<b>735 908 507</b>	1.140	6.9	4.9	160	55	40
225 - 200	10 / 10	<b>735 908 508</b>	1.200	6.9	6.2	160	55	50
250 - 225	10 / 10	<b>735 908 531</b>	1.871	7.7	6.9	182	60	55
280 - 225	10 / 10	<b>735 908 532</b>	2.518	8.6	6.9	206	70	55
315 - 225	10 / 10	<b>735 908 533</b>	3.456	9.7	6.9	231	80	55

PF 2 37 249

# Unions for Butt Fusion

35 51 87

## Union (FPM white), PN 16, PVDF-HP

K

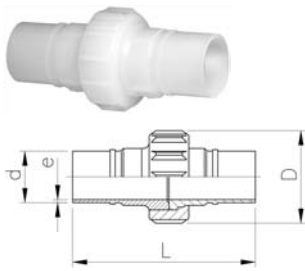

### Model:

- FDA compliant
- supplied with sealing
- d75, d90 and d110 with buttress shaped thread
- \* version without BCF collar (won't be replaced)

- Please see installation instruction

### Note:

- Products, except d75-110, will be replaced in 1. quarter 2007

d [mm]	PN	Code	kg	D [mm]	L [mm]	e [mm]
20	16	735 518 706	0.093	45	137	1.9
25	16	735 518 707	0.130	57	136	1.9
32	16	735 518 708	0.180	62	138	2.4
40	16	735 518 709	0.300	75	176	2.4
50	16	735 518 710	0.419	84	178	3.0
63	16	735 518 711	0.637	101	187	3.0
*75	16	735 528 637	0.740	133	131	3.6
*90	16	735 528 638	0.730	133	131	4.3
*110	16	735 528 639	1.020	155	131	5.3

PF 2 65 434

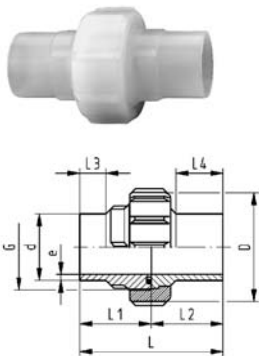

## Union (FPM white), PN 16, PVDF-HP

### Model:

- FDA compliant
- supplied with sealing
- d75, d90 and d110 with buttress shaped thread

- Please see installation instruction

### Note:

- market launch in 1. quarter 2007

d [mm]	PN	Code	kg	e [mm]	D [mm]	L [mm]
20	16	735 528 626		1.9	45	107
25	16	735 528 627		1.9	55	112
32	16	735 528 628		2.4	62	119
40	16	735 528 629		2.4	75	125
50	16	735 528 630		3.0	84	130
63	16	735 528 631		3.0	101	136
*75	16	735 528 637	0.740	3.6	133	131
*90	16	735 528 638	0.730	4.3	133	131
*110	16	735 528 639	1.020	5.3	155	131

PF 2 65 434

## Blanking Union End

d [mm]	d [inch]	PN	DN [mm]	Code	SP	kg	A [mm]	B [mm]	C [inch]	D [mm]
20		232	0	175 482 101	-	0.007				
25		232	0	175 482 102	-	0.015	1	1	1	0
32		232	0	175 482 103	-	0.025	2	1	1	0
50		232	0	175 482 105	-	0.060				
63		232	0	175 482 106	-	0.110				

24 60 06

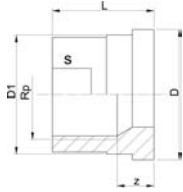
**Union Ends, Stainless Steel 1.4404 (316L)****Rp****A**

PF 2 30 153

**Model:**

- Parallel female thread Rp

Rp [inch]	PN	Code	SP	kg	z [mm]	D [mm]	D1 [mm]	L [mm]	s [mm]
3/8	16	<b>724 600 655</b>	-	0.030	9	24	22	19	19
1/2	16	<b>724 600 656</b>	-	0.060	11	30	28	24	24
3/4	16	<b>724 600 657</b>	-	0.100	11	39	36	26	29
1	16	<b>724 600 658</b>	-	0.140	12	45	42	29	36
1 1/4	16	<b>724 600 659</b>	-	0.230	14	57	53	33	45
1 1/2	16	<b>724 600 660</b>	-	0.320	15	63	59	34	54
2	16	<b>724 600 661</b>	-	0.450	15	78	74	39	63

24 60 07

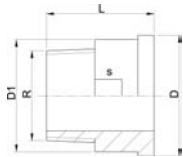
**Union Ends, Stainless Steel 1.4404 (316L)****R****A**

PF 2 30 153

**Model:**

- Taper male thread R

R [inch]	PN	Code	SP	kg	D [mm]	D1 [mm]	L [mm]	s [mm]
3/8	16	<b>724 600 705</b>	-	0.050	24	22	30	19
1/2	16	<b>724 600 706</b>	-	0.090	30	28	34	24
3/4	16	<b>724 600 707</b>	-	0.120	39	36	36	32
1	16	<b>724 600 708</b>	-	0.190	45	42	40	37
1 1/4	16	<b>724 600 709</b>	-	0.350	57	53	46	48
1 1/2	16	<b>724 600 710</b>	-	0.400	63	59	48	54
2	16	<b>724 600 711</b>	-	0.660	78	74	55	69

24 60 55

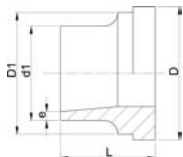
**Union Ends, Stainless Steel 1.4404 (316L)****Welding End****A**

PF 2 30 153

d [mm]	d1 [mm]	PN	Code	SP	kg	D [mm]	D1 [mm]	L [mm]	e [mm]
16	17	16	<b>724 605 505</b>	-	0.030	24	22	18	1.6
20	21	16	<b>724 605 506</b>	-	0.050	30	28	22	2.0
25	26	16	<b>724 605 507</b>	-	0.080	39	36	23	2.0
32	33	16	<b>724 605 508</b>	-	0.110	45	42	26	2.0
40	42	16	<b>724 605 509</b>	-	0.190	57	53	26	2.0
50	48	16	<b>724 605 510</b>	-	0.220	63	59	28	2.0
63	60	16	<b>724 605 511</b>	-	0.370	78	74	32	2.6

35 69 04

**Union nut, PN16, PVDF-Standard**

J

- d75, d90 and d110 with buttress shaped thread

**Note:**

- For the dimensions d75-110 please see instructions for the installation

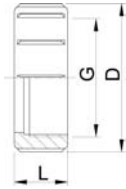

PF 2 35 191

Socket Fusion d [mm]	Butt Fusion d [mm]	PN	Code	kg	D [mm]	G [inch]	L [mm]
16	16	16	<b>735 690 405</b>	0.013	35	3/4	21
20	20	16	<b>735 690 406</b>	0.023	45	1	22
25	25	16	<b>735 690 407</b>	0.047	55	1 1/4	24
32	32	16	<b>735 690 408</b>	0.048	62	1 1/2	26
40	40	16	<b>735 690 409</b>	0.097	75	2	29
50	50	16	<b>735 690 410</b>	0.146	84	2 1/4	33
63	63	16	<b>735 690 411</b>	0.244	101	2 3/4	35
75	75-90	16	<b>735 690 422</b>	0.290	133	S 107,5x3,6	40
90	110	16	<b>735 690 423</b>	0.420	155	S 127,5x3,6	42
110	-	16	<b>735 690 424</b>	0.650	185	S 152,5x3,6	47

24 69 01

**Union nut stainless steel 1.4404 (316L)**

A

\* Octagon union nut

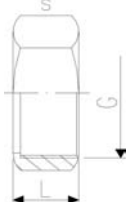

PF 2 30 153

d [mm]	PN	Code	SP	kg	L [mm]	G [inch]	s [mm]
16	16	<b>724 690 105</b>	-	0.060	19	¾	32
20	16	<b>724 690 106</b>	-	0.110	21	1	41
25	16	<b>724 690 107</b>	-	0.100	23	1 ¼	46
32	16	<b>724 690 108</b>	-	0.170	24	1 ½	55
*40	16	<b>724 690 109</b>	-	0.240	27	2	68
*50	16	<b>724 690 110</b>	-	0.300	31	2 ¼	74
*63	16	<b>724 690 111</b>	-	0.390	35	2 ¾	88

49 41 10

**O-Ring, FPM white**

- For SYGEF® Plus Union and diaphragm valve SYGEF® Plus type 314

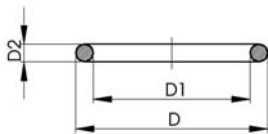

PF 2 65 434

d [mm]	PN	Code	kg	D [mm]	D1 [mm]	D2 [mm]
20	16	<b>749 411 005</b>	0.002	20.7	15.5	2.6
25	16	<b>749 411 006</b>	0.002	27.2	20.2	3.5
32	16	<b>749 411 120</b>	0.002	33.6	26.6	3.6
40	16	<b>749 411 062</b>	0.003	41.6	34.5	3.6
50	16	<b>749 411 172</b>	0.003	51.1	44.0	3.5
63	16	<b>749 411 054</b>	0.005	63.0	55.0	4.0
75	16	<b>749 411 014</b>	0.012	75.5	81.9	5.3
90	16	<b>749 411 015</b>	0.015	90.0	101.0	5.3
110	16	<b>749 411 016</b>	0.031	110.0	120.0	7.0

# Transition Fittings and Sanitary Adaptors

35 91 07

## Adaptor Nipple, male thread - R, PN 16, PVDF-HP

### Model:

- With taper male thread
- Connection to plastic thread only
- Do not use thread sealing pastes that are harmful to PVDF
- Avoid stresses when installing and large changes in temperature

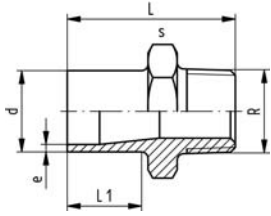

PF 2 35 421

d [mm]	R [inch]	PN	Code	kg	e [mm]	L [mm]	s [mm]	L1 [mm]
20	1/2	16	<b>735 910 706</b>	0.020	1.9	53	32	28
25	3/4	16	<b>735 910 707</b>	0.021	1.9	55	36	28
32	1	16	<b>735 910 708</b>	0.034	2.4	57	46	28
40	1 1/4	16	<b>735 910 709</b>	0.058	2.4	60	55	28
50	1 1/2	16	<b>735 910 710</b>	0.087	3.0	63	65	28
63	2	16	<b>735 910 711</b>	0.118	3.0	69	75	29

35 91 43

## Adaptor Nipple, male thread - NPT, PN 16, PVDF-HP

### Model:

- With taper male thread
- Connection to plastic thread only
- Do not use thread sealing pastes that are harmful to PVDF
- Avoid stresses when installing and large changes in temperature

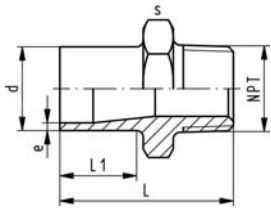

PF 2 65 460

d [mm]	NPT [inch]	PN	Code	kg	e [mm]	L [mm]	s [mm]	L1 [mm]
20	1/2	16	<b>735 914 306</b>	0.016	1.9	53	32	28
25	3/4	16	<b>735 914 307</b>	0.021	1.9	55	36	28
32	1	16	<b>735 914 308</b>	0.035	2.4	57	46	28
40	1 1/4	16	<b>735 914 309</b>	0.057	2.4	60	55	28
50	1 1/2	16	<b>735 914 310</b>	0.085	3.0	63	65	28
63	2	16	<b>735 914 311</b>	0.119	3.0	69	75	29

35 91 07

## Adaptor Socket, female thread - Rp, PN 16, PVDF-HP

### Model:

- With parallel female thread Rp
- Connection to plastic thread only
- Do not use thread sealing pastes that are harmful to PVDF
- Avoid stresses when installing and large changes in temperature

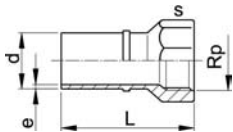

PF 2 65 434

d [mm]	Rp [inch]	PN	Code	kg	e [mm]	L [mm]	s [mm]	L1 [mm]
20	1/2	16	<b>735 910 736</b>	0.020	1.9	58	30	28
25	3/4	16	<b>735 910 737</b>	0.060	1.9	60	35	28
32	1	16	<b>735 910 738</b>	0.090	2.4	65	45	28
40	1 1/4	16	<b>735 910 739</b>	0.130	2.4	85	54	28
50	1 1/2	16	<b>735 910 740</b>	0.170	3.0	85	60	28
63	2	10	<b>735 910 741</b>	0.250	3.0	93	76	29

35 91 44

**Adaptor Socket, female thread - NPT, PN 16, PVDF-HP****Model:**

- Connection to plastic or metal
- Do not use thread sealing pastes that are harmful to PVDF
- Avoid stresses when installing and large changes in temperature

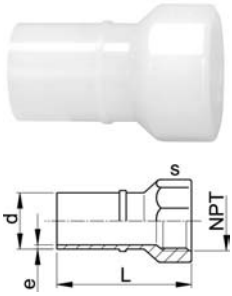

PF 2 65 460

d [mm]	NPT [inch]	PN	Code	kg	e [mm]	L [mm]	s [mm]
25	½	16	<b>735 914 406</b>	0.021	1.9	58	30
25	¾	16	<b>735 914 407</b>	0.028	1.9	60	35
32	1	16	<b>735 914 408</b>	0.049	2.4	65	45
40	1 ¼	16	<b>735 914 409</b>	0.084	2.4	85	54
50	1 ½	16	<b>735 914 410</b>	0.110	3.0	85	60
63	2	10	<b>735 914 411</b>	0.173	3.0	93	76

**Hose Adapter, PN 16, PVDF-HP****K****Model:**

- With butt fusion spigot

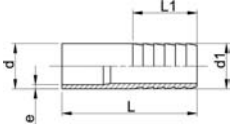

PF 2 37 423

d - d1 [mm]	PN	e [mm]	L [mm]	L1 [mm]	Code	kg
20 - 20	16	1.9	64	27	<b>735 968 731</b>	0.001
25 - 25	16	1.9	75	36	<b>735 968 732</b>	0.001
32 - 32	16	2.4	82	36	<b>735 968 733</b>	0.001
40 - 40	16	2.4	84	42	<b>735 968 734</b>	0.001
50 - 50	16	3.0	90	48	<b>735 968 735</b>	0.150
63 - 60	16	3.0	100	50	<b>735 968 736</b>	0.001

**Flare Transition Fitting, PN 16, PVDF-HP****K**

d [mm]	tube size [inch]	PN	Code	kg	D [mm]	e [mm]	L [mm]	L1 [mm]	L2 [mm]
20	¼	16	<b>735 991 430</b>	0.017	19	1.9	74	43	31
20	⅜	16	<b>735 991 431</b>	0.020	22	1.9	77	46	31
20	½	16	<b>735 991 432</b>	0.025	25	1.9	79	48	31
20	¾	16	<b>735 991 433</b>	0.017	34	1.9	83	52	31
25	¼	16	<b>735 991 435</b>	0.020	19	1.9	74	43	31
25	⅜	16	<b>735 991 436</b>	0.022	22	1.9	77	46	31
25	½	16	<b>735 991 437</b>	0.027	25	1.9	79	48	31
25	¾	16	<b>735 991 438</b>	0.045	34	1.9	83	52	31
25	1	16	<b>735 991 439</b>	0.014	37	1.9	84	58	31
32	½	16	<b>735 991 442</b>	0.034	25	2.4	79	48	31
32	¾	16	<b>735 991 443</b>	0.050	34	2.4	83	52	31
32	1	16	<b>735 991 444</b>	0.035	37	2.4	89	58	31

PF 2 65 434

# Sanitary Adaptors

## Sanitary Adaptor, PN 16, PVDF-HP, with stainless reinforcement ferrule ISO 1127

K

\* Model without chamfer

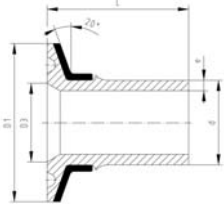

PF 2 65 456

d [mm]	DN [mm]	PN	Code	kg	e [mm]	D1 [mm]	D3 [mm]	L [mm]
20	15	16	<b>735 598 006</b>	0.032	1.9	50	18	49
25	20	16	<b>735 598 008</b>	0.042	1.9	50	24	55
25	25	16	<b>735 598 009</b>	0.041	1.9	50	30	55
32	25	16	<b>735 598 010</b>	0.045	2.4	50	30	57
40	32	16	<b>735 598 014</b>	0.073	2.4	64	35	67
*50	40	16	<b>735 598 016</b>	0.083	3.0	64	44	68
*63	50	16	<b>735 598 018</b>	0.107	3.0	78	56	71

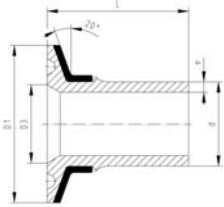

PF 2 65 456

## Sanitary Adaptor, PN 16, PVDF-HP, with stainless reinforcement ferrule DIN 32676

K

\* Model without chamfer

d [mm]	DN [mm]	PN	Code	kg	e [mm]	D1 [mm]	D3 [mm]	L [mm]
*20	15	16	<b>735 598 056</b>	0.020	1.9	34	16	49
20	20	16	<b>735 598 057</b>	0.020	1.9	34	20	49
25	25	16	<b>735 598 059</b>	0.042	1.9	50	26	55
32	32	16	<b>735 598 062</b>	0.045	2.4	50	32	57
40	40	16	<b>735 598 065</b>	0.047	2.4	50	38	67
50	50	16	<b>735 598 067</b>	0.081	3.0	64	50	68

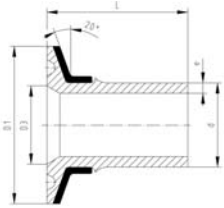

PF 2 65 456

## Sanitary Adaptor, PN 16, PVDF-HP, with stainless reinforcement ferrule BS 4825 (inch)

K

\* Model without chamfer

d [mm]	Inch	PN	Code	kg	e [mm]	D1 [mm]	D3 [mm]	L [mm]
20	3/4	16	<b>735 598 157</b>	0.040	1.9	50	22	49
*25	1	16	<b>735 598 159</b>	0.042	1.9	50	22	49
32	1 1/2	16	<b>735 598 163</b>	0.044	2.4	50	35	57
40	1 1/2	16	<b>735 598 165</b>	0.047	2.4	50	35	67
50	2	16	<b>735 598 167</b>	0.082	3.0	64	48	68
63	2 1/2	16	<b>735 598 169</b>	0.107	3.0	78	60	71



## Sanitary Adaptor, PN 16, PVDF-HP, with stainless reinforcement ferrule 3A Standard

K

<sup>1</sup> Model without stainless reinforcement

\* Model without chamfer

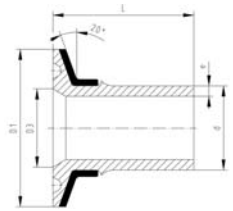

PF 2 65 456

d [mm]	Inch	PN	Code	kg	e [mm]	D1 [mm]	D3 [mm]	L [mm]
<sup>1</sup> *20	3/4	16	735 598 207	0.011	1.9	25	16	49
*25	1	16	735 598 209	0.042	1.9	50	22	49
32	1 1/2	16	735 598 213	0.044	2.4	50	35	57
40	1 1/2	16	735 598 215	0.047	2.4	50	35	67
50	2	16	735 598 217	0.082	3.0	64	48	68
63	2 1/2	16	735 598 219	0.107	3.0	78	60	71



## Sanitary Adaptor, PN 16, PVDF-HP, with stainless reinforcement DIN 3017

K

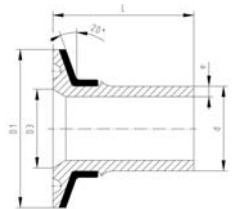

PF 2 65 456

d [mm]	DN [mm]	PN	Code	kg	e [mm]	D1 [mm]	D3 [mm]	L [mm]
25	25	16	735 598 259	0.042	1.9	50	23	55
32	32	16	735 598 262	0.042	2.4	50	31	57
40	40	16	735 598 265	0.047	2.4	50	36	67
50	50	16	735 598 267	0.081	3.0	64	49	68
63	65	16	735 598 269	0.107	3.0	78	60	71



## Sanitary Adaptor, PN 16, PVDF-HP, with stainless reinforcement ISO 2852

K

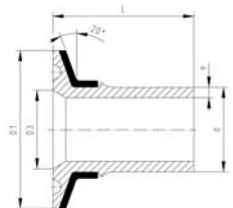

PF 2 65 456

d [mm]	DN [mm]	PN	Code	kg	e [mm]	D1 [mm]	D3 [mm]	L [mm]
25	25	16	735 598 309	0.042	1.9	50	23	55
32	32	16	735 598 312	0.045	2.4	50	31	57
40	40	16	735 598 315	0.047	2.4	50	36	67
50	50	16	735 598 317	0.081	3.0	64	49	68
63	65	16	735 598 319	0.107	3.0	78	60	71



## Sanitary Adaptor, PN 16, PVDF-HP, with stainless reinforcement ASME BPE

K

<sup>1</sup> Model without stainless reinforcement

\* Model without chamfer

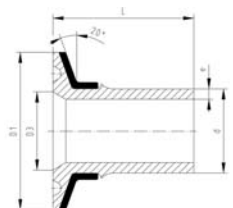

PF 2 65 456

d [mm]	Inch	PN	Code	kg	e [mm]	D1 [mm]	D3 [mm]	L [mm]
<sup>1</sup> *20	3/4	16	735 598 357	0.011	1.9	25	16	49
25	1	16	735 598 359	0.042	1.9	50	22	55
32	1 1/2	16	735 598 362	0.044	2.4	50	35	57
40	1 1/2	16	735 598 365	0.047	2.4	50	35	57
50	2	16	735 598 367	0.082	3.0	64	48	68
63	2 1/2	16	735 598 369	0.107	3.0	78	60	71





## Sanitary Adaptor, PN 16, PVDF-HP, with stainless reinforcement JIS G3447

K

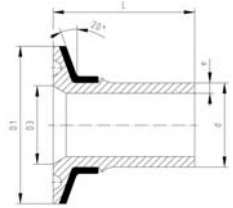

d [mm]	DN [mm]	PN	Code	kg	e [mm]	D1 [mm]	D3 [mm]	L [mm]
20	15	16	735 598 406	0.020	1.9	34	18	49
25	20	16	735 598 408	0.042	1.9	50	23	55
32	25	16	735 598 410	0.045	2.4	50	29	57
40	32	16	735 598 414	0.047	2.4	50	36	67
50	40	16	735 598 416	0.082	3.0	64	48	68
63	50	16	735 598 418	0.107	3.0	78	60	71

PF 2 65 456



## Sanitary Adaptor, PN 16, PVDF-HP, with stainless reinforcement ferrule for Mebrane Manometer

K

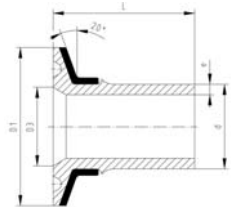

d [mm]	DN [mm]	PN	Code	kg	e [mm]	D1 [mm]	D3 [mm]	L [mm]
20	15	16	735 598 506	0.038	1.9	50	34	49
25	20	16	735 598 508	0.041	1.9	50	34	55
32	25	16	735 598 510	0.045	2.4	50	34	57

PF 2 65 456



## Sanitary Adaptor, PN 16, PVDF-HP, with stainless reinforcement for PVDF-PVDF connection

K

Model:

- without chamfer for completely evacuation even in horizontal installation

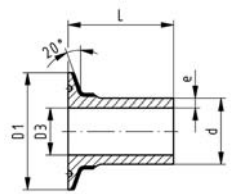

d [mm]	PN	Code	kg	e [mm]	D1 [mm]	D3 [mm]	L [mm]
20	16	735 598 806	0.041	1.9	50.5	16.7	49
25	16	735 598 807	0.044	1.9	50.5	19.9	55
32	16	735 598 808	0.049	2.4	50.5	25.6	57
40	16	735 598 809	0.079	2.4	64.0	33.4	67
50	16	735 598 810	0.090	3.0	64.0	42.2	68
63	16	735 598 811	0.118	3.0	77.5	55.1	71

PF 2 65 456

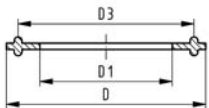

## Gasket PTFE

Model:

- Special gasket for Sanitary Adaptors PVDF-PVDF connection

d [mm]	Code	SP	kg	D [mm]	D1 [mm]	D2 [mm]
20	743 400 806	-	0.010	50.5	16.9	43.5
25	743 400 807	-	0.010	20.1	50.5	43.5
32	743 400 808	-	0.010	25.8	50.5	43.5
40	743 400 809	-	0.015	33.6	64.0	56.5
50	743 400 810	-	0.015	42.5	64.0	56.5
63	743 400 811	-	0.017	55.4	77.5	70.5

PF 2 65 456

# Flange Adaptors, Flanges and Gaskets

35 79 88

## Flange Adaptors PN16; jointing face serrated, PVDF-HP **K**

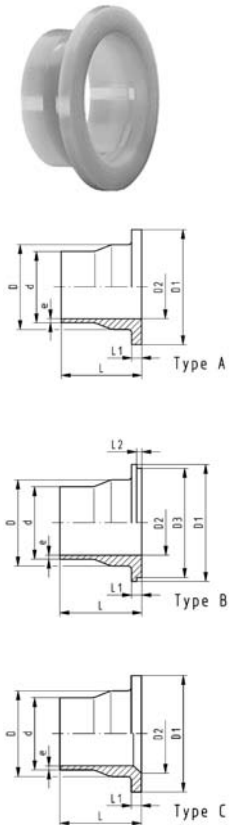

PF 2 37 249

d [mm]	DN [mm]	PN	Code	kg	D [mm]	D1 [mm]	D2 [mm]	D3 [mm]	e [mm]	L [mm]	L1 [mm]	L2 [mm]	Type
20	15	16	<b>735 798 831</b>	0.029	26	45	15		1.9	54	6		A
25	20	16	<b>735 798 832</b>	0.044	32	58	20	54	1.9	56	7	4	B
32	25	16	<b>735 798 833</b>	0.066	40	68	26	63	2.4	58	7	4	B
40	32	16	<b>735 798 834</b>	0.093	49	78	34	73	2.4	68	8	4	B
50	40	16	<b>735 798 835</b>	0.129	60	88	42	82	3.0	69	8	4	B
63	50	16	<b>735 798 836</b>	0.187	75	102	56		3.0	72	9		A
75	65	16	<b>735 798 837</b>	0.298	89	122	66		3.6	80	10		A
90	80	16	<b>735 798 838</b>	0.377	105	138	78	133	4.3	81	12	4	B
110	100	16	<b>735 798 839</b>	0.630	125	158	100		5.3	81	13		C
140	125	16	<b>735 798 841</b>	0.847	155	188	127		6.7	90	16		C
160	150	16	<b>735 798 842</b>	1.200	175	212	151		7.7	93	17		C
200	200	16	<b>735 798 844</b>	1.900	232	268	203		9.6	102	22		C
225	200	16	<b>735 798 845</b>	2.000	235	268	203		10.8	102	22		C

35 79 88

## Flange Adaptors PN16, ANSI, jointing face serrated, PVDF-HP **K**

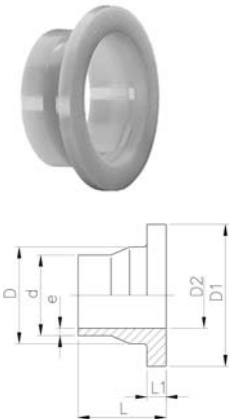

PF 2 37 249

### Model:

- Other dimensions identical with metric version

d [mm]	PN	Code	kg	D [mm]	D1 [mm]	D2 [mm]	e [mm]	L [mm]	L1 [mm]
25	16	<b>735 798 882</b>	0.043	32	54	20	1.9	56	7
32	16	<b>735 798 883</b>	0.063	40	63	26	2.4	58	7
40	16	<b>735 798 884</b>	0.089	49	73	34	2.4	68	8